



A-KRAFT FOAM TRAY INSERTED SYSTEM

TOOL CABINET AND CHEST



The Fashionable Classic Series

- Serve all professional needs.
- Armed with excellent products for experts, along with a CHIC look.
- Coated durable glossy powder finish, easy to clean and maintain.
- Look charming in every garage.

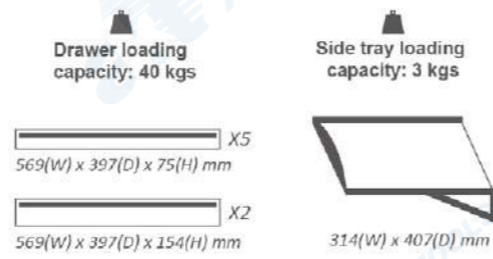
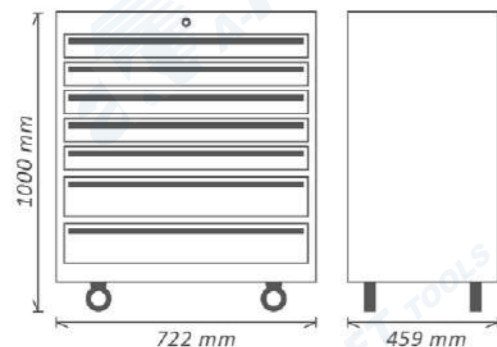

7 DRAWERS

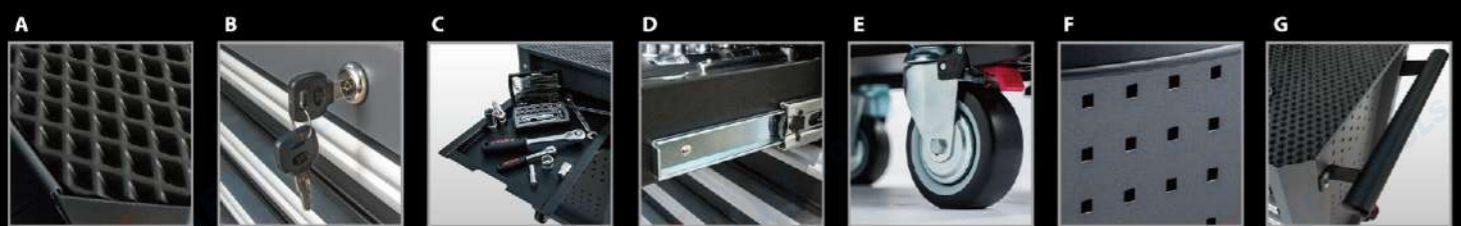

5 & 7 DRAWER ROLLER CABINET

Product Features:

- * Double-wall construction for sturdy and durable frame.
- * High specification ball bearing slides.
- * Full-extension drawers to access tools easily. Bases protected by EVA mat.
- * Comfort handle to push, pull and turn easily.
- * Central locking system.
- * Non-slip top mat for worktop protection.
- * Thickness of iron sheet : Body:1.0 mm. Drawer: 0.8 mm.
- * 5x2" TPR high-performance wheels, 2 fixed, 2 swiveling w/brake.
- * Maximum static loading capacity: 700kgs.
- * Drawer loading capacity: 40kgs.

Item Nr. C10501

Product	Qty	Length	Width	Height	Unit: mm
Cabinet (W/caster)		722	459	1000	
Cabinet		722	459	828	
Drawer	1	569	397	75	
Drawer	4	569	397	154	

Item Nr. C10702

Product	Qty	Length	Width	Height	Unit: mm
Cabinet (W/caster)		722	459	1000	
Cabinet		722	459	828	
Drawer	5	569	397	75	
Drawer	2	569	397	154	

Item Nr. C10501



Item Nr. C10702



4 DRAWER TOP CHEST

Product Features:

- * Double-wall construction for sturdy and durable frame.
- * High specification ball bearing slides.
- * Full-extension drawer & bases protected by EVA mat.
- * Side handles for transport with ease.
- * Central locking system.
- * Non-slip top mat for worktop.
- * Thickness of iron sheet : Body:1.0 mm. Drawer: 0.8 mm.
- * Drawer loading capacity: 40kgs.
- * Standard color: red, blue, black.

Item Nr. C20401

Product	Qty	Length	Width	Height	Unit: mm
Cabinet		722	459	450	
Drawer	4	569	397	75	



The A-KRAFT Premium Series

- Developed for people who are looking for professional quality tools and features.
- Comes loaded with supreme products for experts, combined with modern styling, offering you the super best that A-KRAFT Tools always provides.
- Curve design with extra reinforcement reduces impact injury.
- Durable glossy powder coat finish makes it easy to clean and looks brilliant in every garage.

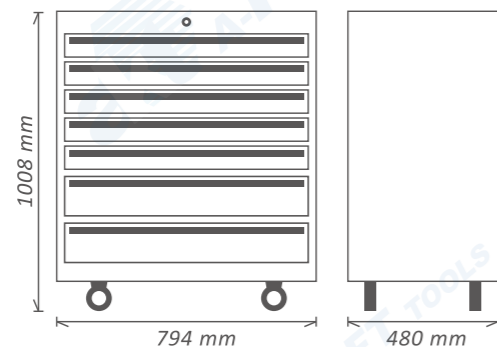
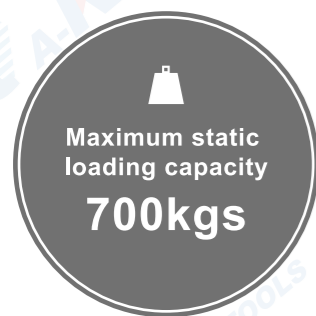

Drawer loading capacity: 40 kgs

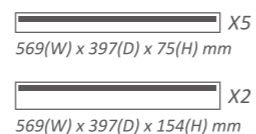

Side tray loading capacity: 3 kgs

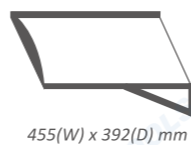

7 DRAWER ROLLER CABINET

Product Features:

- * Ball bearing slides. Curve body reduces impact injury.
- * Foldaway side trays on both sides with liners.
- * Rear locking mechanism, actuated by lid and cam lock.
- * Oil-proof, 5 x 2" TPR high-performance wheels, 2 fixed, 2 swiveling w/brake.
- * Full-extension drawers to access tools easily. Bases protected by EVA mat.
- * Built-in heavy duty handle to push, pull and turn easily.
- * Non-slip top mat for worktop protection.
- * High specification ball bearing slides.
- * Maximum static loading capacity: 700kgs.
- * Drawer loading capacity: 40kgs.
- * Standard color: red, blue, black.



Item Nr. C10701

Unit: mm

Product	Qty	Length	Width	Height
Cabinet		794	480	849
Drawer	5	569	397	75
Drawer	2	569	397	154

6 DRAWER TOP CHEST

Product Features:

- * Ball bearing slides.
- * Rolled edges to strengthen drawer sides.
- * Gas struts for operating the lid smoothly and securely.
- * Reinforced trolley base.
- * Premium quality powder coated finish.
- * Most accessories supplied as standard.
- * Thickness of iron sheet : Body:0.8 mm. Drawer: 0.6 mm.
- * Drawer loading capacity: 40kgs.
- * Standard color: red, blue, black.



Item Nr. C20601

Unit: mm

Product	Qty	Length	Width	Height
Cabinet		701	320	398.5
Drawer	3	168	271	50
Drawer	2	568	271	50
Drawer	1	568	271	75

5 LAYER CANTILEVER TOOL BOX

Product Features:

- * Cantilever style tool box with 5 compartments.
- * By pulling the handles to open the box smoothly.
- * Sturdy iron sheet.
- * Standard color: red, blue, black.

Item Nr. C30501

Unit: mm

Product	Qty	Length	Width	Height
Cabinet		470	220	230
Layer	4	470	105	53.5
Bottom layer	1	465	220	69



MINI BITTY TOOL CHEST

Product Features:

- * Heavy Duty Tool Chest: The case with 1.2mm in thickness of metal sheet.
- * Continuous hinge gives stronger holds and is not easy to break.
- * Standard color: red, blue, black.

Item Nr. C40301

Unit: mm

Product	Qty	Length	Width	Height
Cabinet		275	152	150
Top layer	1	275	145	34
Drawer	2	215	130	39.5



Thickness Comparison



Heavy Duty Tool Chest

The case with 1.2mm in thickness of metal sheet which will not be damaged easily by any collision caused in falling or hitting.

Hinge Comparison



Continuous Hinge

Comparing with the general metal case which only uses 2 to 4 hinges for the connections. Continuous hinge gives stronger holds and is not easy to be broken.

A-KRAFT FOAM TRAY INSERTED SYSTEM

Provides four sizes / contents for option.

The sizes / contents can be tailored and specifically produced by request.

- One drawer can be fitted into four single pieces of foams.
- Single, double, triple and fourfold types of foam could be arranged based on demands.
- Four sizes of foams give various combinations to be available for a wide range of tool trolleys and chests.
- The foam tray is durable and holds each tool properly tight, ensuring excellent tool organization and neat arrangement.

MODULAR SIZES OF FOAM TRAY

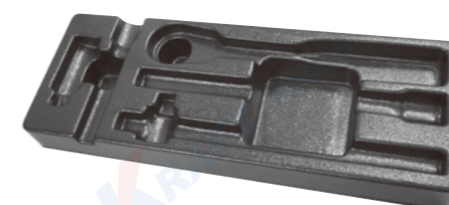
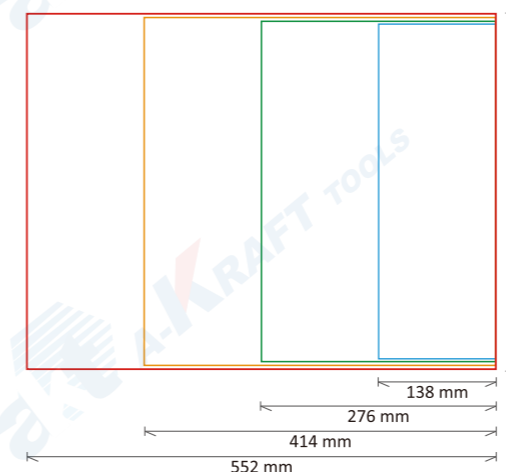

BEFORE

Normal type PS plastic tray.
Not fit the tools tightly.
Easy to break.

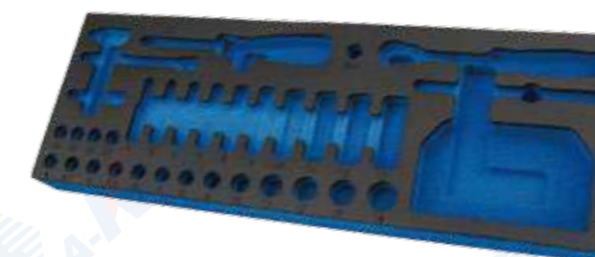

AFTER

- ★ Each engraving space on EVA foam perfectly and appropriately fits the tool.
- ★ Flexible, bending resistant and durable
- ★ Neat arrangement leads users to catch what they need at a glance.
- ★ Various colors and surface textures are available
- ★ Smarter storage system.

EVA/PE Foam Tray Features

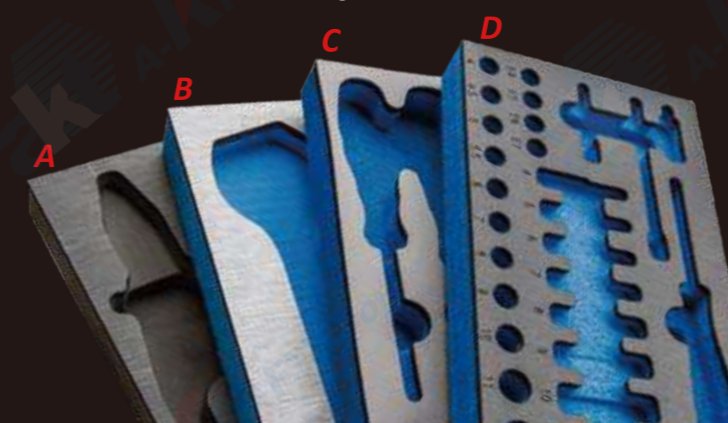

- A. Metallic Skin (black):**
Bottom with dual color EVA Foam for option.
- B. Metallic Skin (silver):**
Bottom with dual color EVA Foam for option.
- C. VR+PE Foam:**
Embossment engraving on top VR layer,
Bottom dual color PE Foam.
- D. Dual color PE Foam:**
Neutral materials especially suit for metal packing.

A-KRAFT MODULAR TOOL ASSORTMENTS

SIZE 394 x 138 x 34 mm



3 PC Plier Set

Item Nr. TP 1030

- 1- Locking Plier 250 mm
- 1- Combination Plier 180 mm
- 1- Water Pump Plier 250 mm



4 PC T Type Handle Ball Point Hex Wrench Set

Item Nr. TL 1040

- 4- Hex Sizes:
Hex 6 x 150 mm, Hex 8 x 200 mm,
Hex 10 x 200 mm, Hex 12 x 200 mm.



4 PC Plier and Adjustable Wrench Set

Item Nr. TP 1040

- 1- Combination Plier 180 mm.
- 1- Long Nose Plier 200 mm.
- 1- Diagonal Cutting Plier 160 mm.
- 1- Heavy Duty Type Adjustable Wrench 250 mm.



6 PC T Type Handle Ball Point Hex Wrench Set

Item Nr. TL 1061

- 6- Hex Sizes:
Hex 2 x 100 mm, Hex 2.5 x 100 mm,
Hex 3 x 100 mm, Hex 4 x 150 mm,
Hex 5 x 150 mm, Hex 5.5 x 150 mm.



4 PC Plier Set

Item Nr. TP 1041

- 1- Combination Plier 180 mm.
- 1- Long Nose Plier 200 mm.
- 1- Diagonal Cutting Plier 160 mm.
- 1- Water Pump Plier 250 mm.

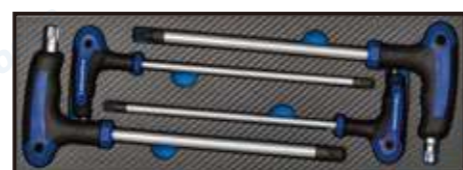

4 PC T Type Handle TX Wrench Set

Item Nr. TL 1041

- 4- TX with tamperproof:
TTX 40 x 200 mm, TTX 45 x 200 mm,
TTX 50 x 200 mm, TTX 55 x 200 mm.

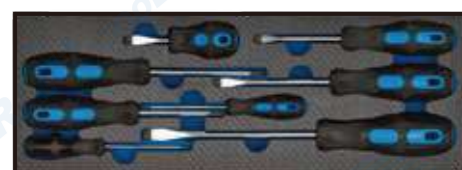

8 PC Screwdriver Set

Item Nr. TD 1080

- 5- Slotted type:
6.5 x 38, 3 x 75, 5.5 x 75, 6.5 x 100, 8 x 150 mm.
- 3- Phillips type:
#0 x 75, #1 x 75, #2 x 100 mm.



6 PC T Type Handle Star TX Wrench Set

Item Nr. TL 1060

- 6- TX with tamperproof:
TTX 10 x 100 mm, TTX 15 x 100 mm,
TTX 20 x 100 mm, TTX 25 x 150 mm,
TTX 27 x 150 mm, TTX 30 x 150 mm.

A-KRAFT MODULAR TOOL ASSORTMENTS

SIZE 394 x 138 x 34 mm



4 PC Combination Wrench Set

Item Nr. TW 1041

- 4- Combination Wrenches:
22, 23, 24, 27 mm.



10 PC Double Open Ended Wrench Set

Item Nr. TW 2100

- 10- Double Open Ended Wrenches:
6 x 7, 8 x 9, 10 x 11, 12 x 13, 14 x 15, 16 x 17,
18 x 19, 20 x 22, 24 x 27, 30 x 32 mm.

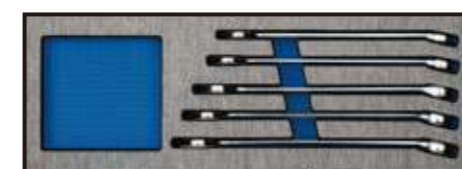

5 PC Combination Wrench Set

Item Nr. TW 1051

- 5- Combination Wrenches:
17, 18, 19, 20, 21 mm.



4 PC Double Ring Wrench Set 75 degree

Item Nr. TW 3040

- 4- Double Ring Wrenches:
20 x 22, 21 x 23, 24 x 27, 30 x 32 mm.



13 PC Combination Wrench Set

Item Nr. TW 1130

- 13- Combination Wrenches:
6, 7, 8, 9, 10, 10, 11, 12, 13, 13, 14, 15, 16 mm.



6 PC Double Ring Wrench Set 75 degree

Item Nr. TW 3060

- 6- Double Ring Wrenches:
8 x 9, 10 x 11, 12 x 13, 14 x 15, 16 x 17, 18 x 19 mm.

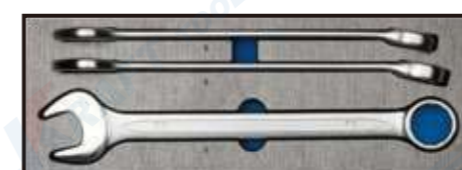

3 PC Combination Wrench Set

Item Nr. TW 1030

- 3- Combination Wrenches:
29, 30, 32 mm.

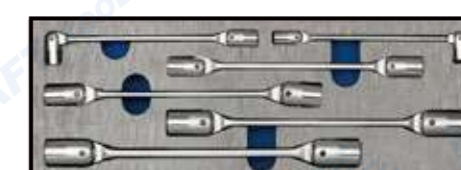

6 PC Double Flex Socket Wrench Set

Item Nr. TW 4060

- 6- Double Flex Socket Wrenches:
8 x 9, 10 x 11, 12 x 13, 14 x 15, 16 x 17, 18 x 19 mm.

A-KRAFT MODULAR TOOL ASSORTMENTS

SIZE 394 x 138 x 34 mm



65 PC 1/4"DR. Socket Set

Item Nr. TS 2650

- 13- Sockets:
4, 4.5, 5, 5.5, 6, 7, 8, 9, 10, 11, 12, 13, 14 mm.
- 10- Deep Sockets:
4, 5, 6, 7, 8, 9, 10, 11, 12, 13 mm.
- 4- E-type Sockets: E4, 5, 6, 7.
- 7- Accessories:
Extension bars: 50, 100 mm, Sliding T-handle, Universal joint, Spinner handle, Coupler for bits, Ratchet KH3000.
- 31 PCS Bits Box.



7 PC 1/2"DR. Socket Set

Item Nr. TS 4070

- 7- Accessories:
Ratchet KH3000, Extension bars: 125, 250 mm, Universal joint, Spark plug sockets: 16, 21 mm, 3/8"DR. Female x 1/2"DR. Male adaptor (3 ways).



10 PC 1/2"DR. Screwdriver Socket Set

Item Nr. TS 4100

- 10- Screwdriver Sockets (138 mm):
Hex: 5, 6, 7, 8, 9, 10, 12, 14, 17, 19 mm.



24 PC 3/8"DR. Socket Set

Item Nr. TS 3240

- 18- Sockets:
6, 7, 8, 9, 10, 11, 12, 13, 14, 15, 16, 17, 18, 19, 20, 21, 22, 24 mm.
- 6- Accessories:
Spark plug sockets: 16, 21 mm, Extension bar 75 mm, Universal joint, Sliding T-handle 200 mm, Ratchet KH3000.



24 PC 1/2"DR. Socket Set

Item Nr. TS 4240

- 20- Sockets:
8, 9, 10, 11, 12, 13, 14, 15, 16, 17, 18, 19, 20, 21, 22, 23, 24, 27, 30, 32 mm.
- 4- Deep Sockets: 17, 18, 21, 22 mm.



5 PC 1/2"DR. Socket Set

Item Nr. TS 4050

- 5- Accessories:
Extension bars: 125, 250 mm, Universal joint, Sliding T-handle 250 mm, Heavy duty type swivel handle 380 mm.



9 PC 1/4" + 1/2"DR. Socket Set

Item Nr. TS 6090

- 5- 1/4"DR. Accessories:
Ratchet KH3000, Extension bars: 50, 100 mm, Sliding T-handle, Universal joint.
- 4- 1/2"DR. Accessories:
Ratchet KH3000, Extension bar 125 mm, Universal joint, Sliding T-handle 250 mm.

A-KRAFT MODULAR TOOL ASSORTMENTS

SIZE 394 x 138 x 34 mm



27 PC 1/2"DR. Socket Set

Item Nr. TS 4270

- 7- E-type Sockets:
E12, 14, 16, 18, 20, 22, 24.
- 6- Screwdriver Sockets (62 mm):
TX: T-30, 40, 45, 50, 55, 60.
- 9- Bits (5/16" x 30 mm):
TTX: T-20, 25, 27, 30, 40, 45, 50, 55, 60. (with tamperproof)
- 4- E-type Wrenches:
E6 x E8, E10 x E12, E14 x E18, E20 x E24 mm.
- 1- Coupler for bits.



9 PC Punch Set

Item Nr. TC 1090

- 6- Pin punches:
2 x 115 mm, 3 x 125 mm, 4 x 150 mm, 5 x 165 mm, 6 x 180 mm, 8 x 180 mm.
- 2- Taper punches:
3 x 120 mm, 4 x 120 mm.
- 1- Center punch:
4 x 120 mm.

A-KRAFT MODULAR TOOL ASSORTMENTS

SIZE 552 x 394 x 34 mm



27 PC 3/4"DR. Socket Set

Item Nr. TS 6270

- 13- Sockets:
19, 21, 22, 24, 27, 30, 32, 35, 36, 38, 41, 46, 50 mm.
- 5- Accessories:
Extension Bars: 100, 200, 400 mm, Sliding T-handle 450 mm, Ratchet KH3000,
- 9- Screwdriver Sockets:
TX: T-60, 70, 80, 90, 100.
Hex: 14, 17, 19, 22 mm.



44 PC 1/2"DR. Impact Socket Set

Item Nr. TA 4440

- 15- Impact Sockets: 8, 9, 10, 11, 12, 13, 14, 15, 16, 17, 18, 19, 21, 22, 24 mm.
- 5- Deep Impact Sockets: 17, 19, 21, 22, 24 mm.
- 3- Impact Accessories:
Universal joint, Extension bars: 125, 250 mm.
- 3- Deep Impact Sockets with magnet (152 mm):
17, 19, 21 mm.
- 17- Impact Screwdriver Sockets:
TX : T-30, 40, 45, 50, 55, 60, 70, 80.
Hex: 5, 6, 7, 8, 10, 12, 14, 17, 19 mm.
- 1- Impact Wrench.



www.akraft.com.tw

One Stop, All Services

You can trust A-KRAFT, we Deliver!!



A-KRAFT Tools Manufacturing Co., Ltd.

No.21-1, Lane 557, Zhongzheng Rd., Wufeng Dist., Taichung City 41359, Taiwan
Tel: 886-4-23327908 (Rep.) Fax: 886-4-23327918 E-mail: info@akraft.com.tw

www.akraft.com.tw



DIN
ISO

